

GD27 Series Smart VFDs



CE

invt

Contents

| | |
|---------------------------------------|----|
| About us | 1 |
| Product introduction..... | 2 |
| Product application..... | 3 |
| Product characteristics..... | 4 |
| Technical parameters..... | 7 |
| Wiring..... | 8 |
| Model description..... | 9 |
| Reactor & filter model selection..... | 10 |
| Accessory model selection..... | 10 |
| Mounting method | 11 |
| INVT marketing service network | 12 |

About us

Shenzhen INVT Electric Co., Ltd. (INVT for short, stock code: 002334) was founded in 2002, focusing on the fields of industrial automation and energy power. It was listed on Shenzhen Stock Exchange (SZSE) and issued A shares in 2010. Adhering to the core values of "Achieve customers, performance orientation, open and win-win cooperation, struggle and innovation" and with the mission of making every effort to offer most valuable products and services to strengthen customer competitiveness, INVT provides differentiated and specialized industry solutions, customized technical services, global localization operations, and digital management models to global customers.

Core competitiveness

Company scale: In 2023, the total operating revenue was approximately RMB 4.59 billion, a year-on-year increase of 12.03%. The net profit was approximately 371 million Yuan, a year-on-year increase of 35.06%. The total assets reached 5.186 billion Yuan, a year-on-year increase of 6.13%. INVT has 4 large bases of production and research, 15 holding subsidiaries, and over 5000 employees.

R&D capability: INVT is a national key high-tech enterprise in China's Torch Program and a drafting unit for the national standard of low-voltage VFDs. It has established a strict quality management system and passed CNAS certification. The R&D testing laboratory has been awarded the Acceptance of Client Testing (ACT) accreditation by TUV-SUD in Germany, and the main products are CE-compliant. INVT has also been recognized as the National Enterprise Technology Center, and Guangdong Engineering Technology Research Center, and has undertaken a number of national, provincial and municipal science and technology projects. By the end of 2023, INVT has 1538 patents and 283 computer software copyrights.

Marketing and service network: INVT has set up dozens of branches and hundreds of joint warranty centers around the world, and has established strong cooperative relationships with many domestic and international channel partners. This comprehensive sales and service network enables INVT to respond quickly to global market demands and provide immediate technical support and quality after-sales service.

Business segments

Industrial automation: Offering VFDs, servo systems, motors, controllers, human-machine interfaces, sensors, elevator drive systems, industrial internet, and other products and integrated solutions, which are widely used in compressors, cranes, solar pumps, printing and packaging machinery, 3C electronics, lithium-ion battery equipment, semiconductor equipment, offshore equipment, iron and steel, petroleum, chemical industry, and other fields.

Network power: Offering micro module data centers, power supply and distribution products, intelligent temperature control products, intelligent monitoring products, and integrated solutions, which are widely used in cloud data centers, finance, communication, medical, energy, and other fields.

New energy vehicle: Offering comprehensive products such as main motor controllers, auxiliary motor controllers, vehicle controllers, and onboard power supplies, covering the full range of solutions for commercial vehicles and passenger cars.

PV energy storage: Offering grid-tie inverters, energy storage inverters, off-grid inverters, monitoring accessories, which have been applied in many scenarios at home and abroad.

Product introduction



Smart VFDs drive a better future

GD27 is a newly designed smart VFD, in compact structure, with excellent performance and rich functions, simple and easy to use. It can be widely used in industries such as woodworking, textiles, food, printing and packaging, plastics, HVAC, logistics and transportation equipment.

Power range:
 AC 1PH 200V~240V 0.4kW~2.2kW
 AC 3PH 200V~240V 0.4kW~4kW
 AC 3PH 380V~480V 0.75kW~7.5kW

| Characteristics | Advantages |
|---|--|
| Embedded EMC filter ¹⁾ | Compliant with EN/IEC61800-3 C3 |
| Embedded STO function ¹⁾ | Compliant with EN/IEC61800-5-2 SIL2 |
| Compact bookstyle design | Support for side-by-side mounting, saving cabinet space |
| Push-in spring-loaded control terminals | Tool free wiring, saving 50% of wiring time |
| Support for DIN rail mounting ²⁾ | Making disassembly and assembly easy, saving time and effort |
| Natural cooling (frame A) | Without noise, good environment adaptability |
| Support for parameter copying keypads | Facilitating batch operation and maintenance |
| Standard models and EU models available | Wide range of models for selection, saving procurement cost |
| Support for IM and PM motors | Enabling customers to select motors as required |
| Enhanced circuit board coating | Improving reliability in hostile environments |
| Pluggable fan | Easy to maintain |
| Embedded braking unit | No external configuration need, saving cost |

¹⁾ The EU models have been embedded with STO and EMC filters as standard configuration.

²⁾ The DIN rail mounting bracket is optional. Only frames A and B support DIN rail mounting.

Product application

Woodworking machinery



Carton machinery

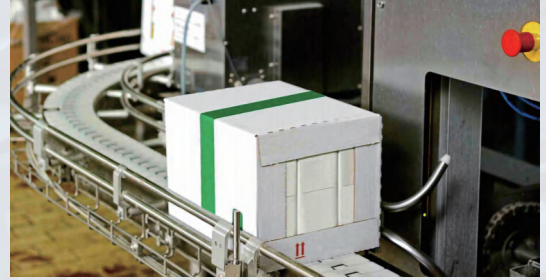

Food machinery



Logistics conveyor line



Textile machinery



Plastic machinery



Stone machinery



Optical devices



Product characteristics

Excellent performance

New generation of motor control platform

Capable of driving asynchronous motors and permanent magnet synchronous motors, supporting SVC and V/F control methods.



Supporting long motor cables

Supporting up to 150m motor cable applications without the need of additional output reactors.



Outstanding torque control

Torque control accuracy < 5%
Torque response time < 10ms



Transient power loss ride-through

When the power grid drops suddenly, the VFD can keep running with the feedback energy within valid time. This function is particularly applicable to scenarios with high requirements for equipment operation continuity.

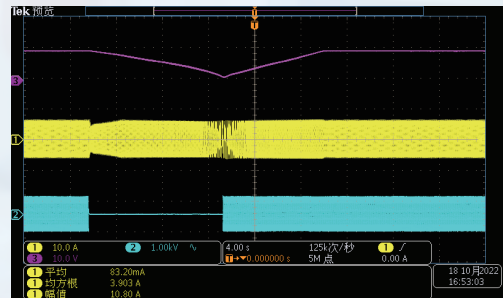

Remarkable load carrying capability at low frequency

Current waveform with sudden 100% load at a low frequency of 0.5Hz.

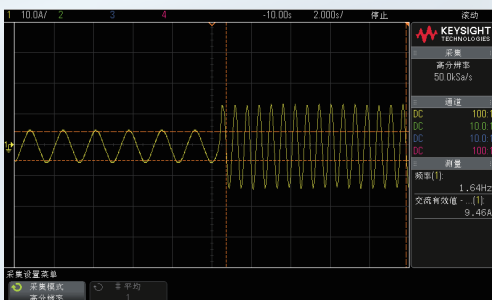

Remarkable load carrying capability at high frequency

Current and voltage waveform of motor at stable running at high frequency.

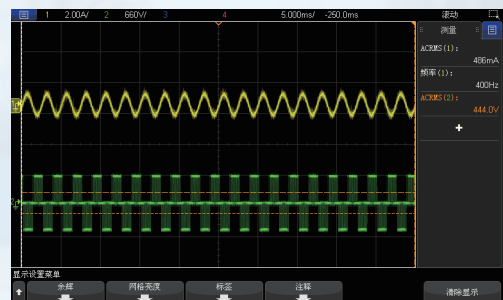

Saving time and increasing efficiency

Easy and flexible mounting

Compact bookstyle design supports side-by-side mounting, saving cabinet space and cost. Frames A and B support optional DIN rail bracket mounting.



Pluggable fan

Wireless fool-proofing design makes assembly, disassembly, and maintenance easy.



Support for external keypads

Both common LED keypads and special LED keypads with the parameter copying function are supported, facilitating batch debugging.

Using an external optional keypad mounting bracket helps monitoring from the external of cabinet.



Push-in spring loaded control terminals

Tool-free wiring, easy and fast, saving the wiring time by 50%.



Safe and reliable

Embedded safety functions

STO compliant with SIL2, which prevents the VFD from starting by mistake and enhances the safety of device maintenance and operation.

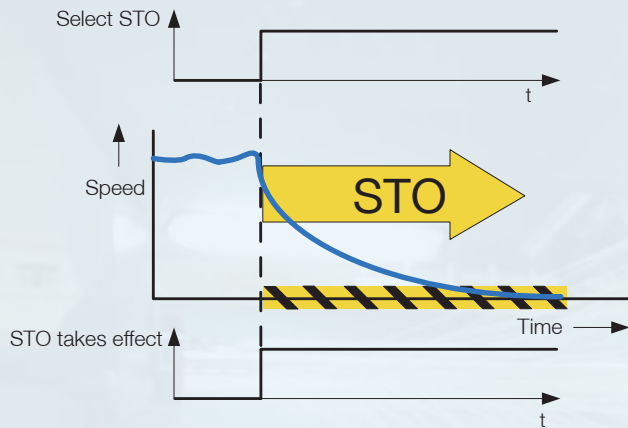

Excellent environment adaptability

Enhanced circuit board coating for reliable running under full load in an environment up to 50 °C. Independent air duct design.



Embedded EMC filter

Compliant with IEC61800-3 C2/C3, effectively reducing electromagnetic interference and ensuring stable equipment running without separate installation of external filter, with less cost.

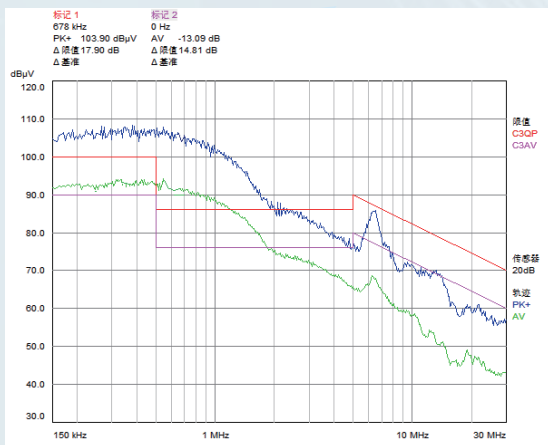

Without filter

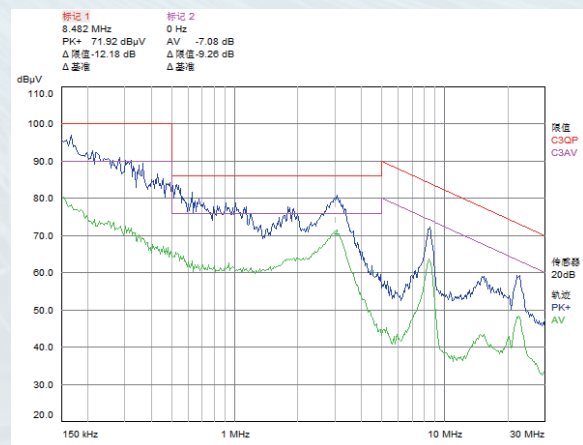

Filter embedded

Power terminal conductivity disturbance test

Note:

Embedded with C2 filters, applicable to civilian environments.
 Embedded with C3 filters, applicable to industrial environments.

Technical parameters

| Item | Specifications |
|------------------------------------|--|
| Input voltage | AC 1PH 200V-240V AC 3PH 200V-240V AC 3PH 380V-480V |
| Input frequency | 50Hz or 60Hz; Allowed range: 47-63Hz |
| Output frequency | 0-599Hz |
| Control mode | Space voltage vector control, and sensorless vector control (SVC) |
| Motor type | Asynchronous motor (AM) and synchronous motor (SM) |
| Speed ratio | For AMs: 1: 100 (SVC); For SMs: 1: 20 (SVC) |
| Speed control accuracy | ±0.2% (SVC) |
| Speed fluctuation | ±0.3% (SVC) |
| Torque response | <10ms (SVC) |
| Torque control accuracy | 5% (SVC) |
| Starting torque | For AMs: 0.25Hz/150% (SVC); For SMs: 2.5Hz/150% (SVC) |
| Overload capacity | 150% of the rated current for 60s, 180% of the rated current for 10s |
| Frequency setting method | Setting through keypad digital, analog, multi-step running, simple PLC, PID, and Modbus communication. Setting combinations and setting channels can be switched |
| Automatic voltage regulation | Able to keep constant output voltage even when the grid voltage changes |
| Fault protection | Including protection against overcurrent, overvoltage, undervoltage, overtemperature, overload, phase loss, and short circuit |
| Analog input | Two inputs. AI1: 0-10V/0-20mA; AI2: 0-10V |
| Analog output | One output. AO1: 0-10V/0-20mA |
| Digital input | Four regular inputs. Max. frequency: 1kHz One high-speed input. Max. frequency: 50kHz |
| Digital output | One Y terminal open collector output |
| Relay output | Two programmable relay outputs RO1A: NO; RO1B: NC; RO1C: common RO2A: NO; RO2B: NC; RO2C: common Contact capacity: 3A/AC250V, 1A/DC30V |
| STO input | STO redundant input, connected to the external NC contact. When the contact opens, STO acts and the VFD stops output. Safety input signal wires use shielded wires whose length is within 25m. The H1 and H2 terminals are short connected to +24V by default. Remove the jumper from the terminals before using the STO function. |
| Altitude | Below 1000m |
| Temperature of storage | -20-70°C |
| Temperature of running environment | -10-50°C ³⁾ |
| RH | < 95% RH, no condensation |
| IP rating | IP20 |
| Braking unit | Embedded braking unit as standard configuration |
| Installation method | Wall mounting, DIN rail mounting, side-by-side mounting |
| Cooling method | Wall mounting, DIN rail mounting, side-by-side mounting Cooling method 1PH/3PH 220V voltage class: natural cooling for 0.75kW and lower 3PH 380V voltage class: natural cooling for 1.5kW and lower Others: Forced air cooling |
| Certification standard | CE requirements are met |

Note: Standard models have two groups of relay, while EU models have a group of relay and a group of STO function terminal.

³⁾ The highest ambient temperature is 40°C when multiple GD27 VFDs are mounted closely side by side.

Wiring

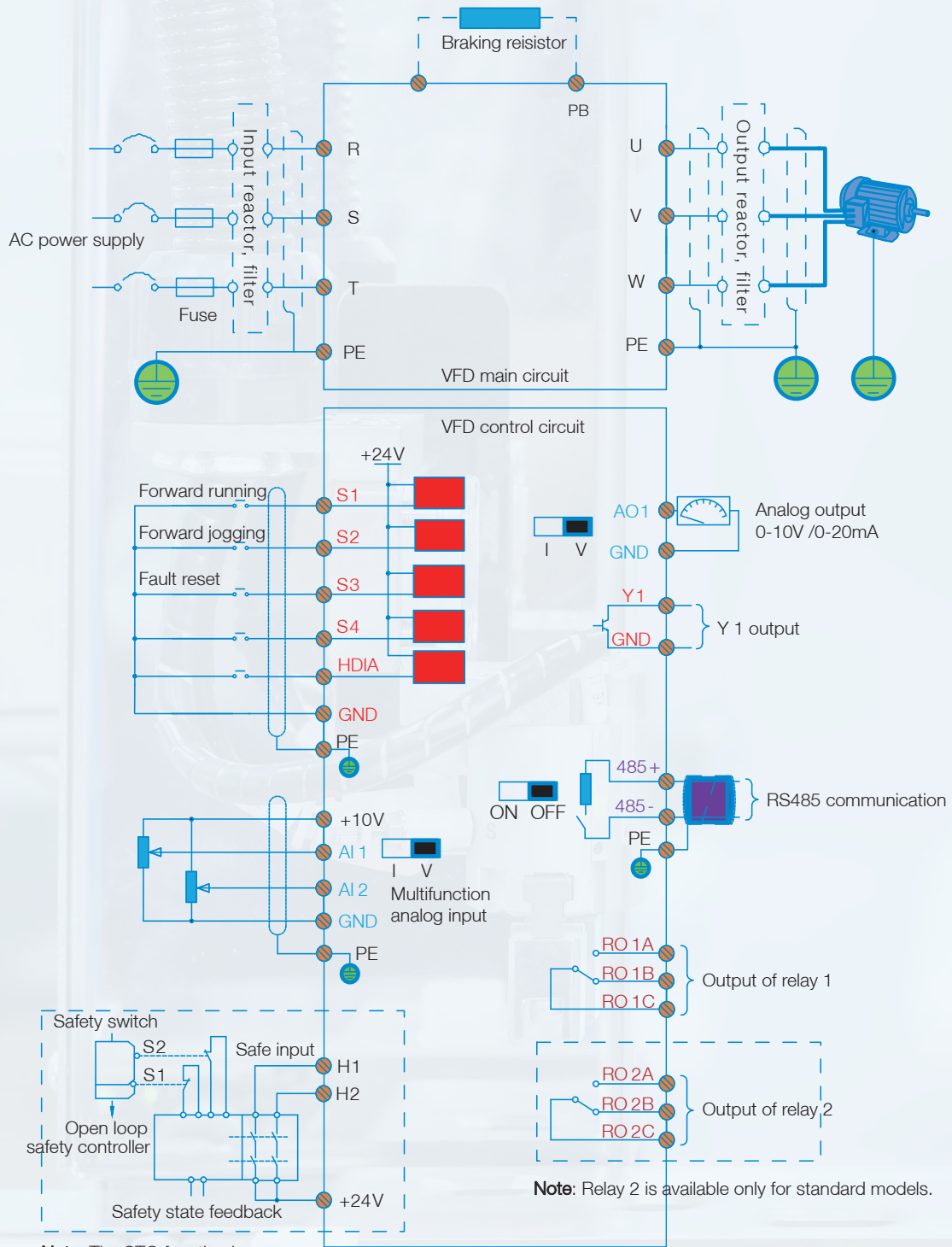

Note: The STO function is available only for EU models.

Note: () : Shield layer / : Twisted pair

Note: Relay 2 is available only for standard models.

Model description

Naming rule

GD27 – 004G -4-B-EU

| Field | Description |
|-----------------------------|--|
| Product series abbreviation | GD27: Goodrive27 series smart VFD |
| Rated power | 004: 4kW G: Constant torque load |
| Voltage class | S2: AC 1 PH 200V~240V 2: AC 3 PH 200V~240V 4: AC 3 PH 380V~480V |
| Braking unit | Empty: No braking unit embedded G: Constant torque load B: Braking unit embedded |
| Management no | Empty: Neither STO nor EMC filter embedded EU: STO and EMC filter embedded |

Product model selection

| VFD model | Output power (kW) | Input current (A) | Output current (A) | Exterior frame |
|-------------------|-------------------|-------------------|--------------------|----------------|
| AC 1PH 200V~240V | | | | |
| GD27-0R4G-S2-B-XX | 0.4 | 6.5 | 2.5 | A |
| GD27-0R7G-S2-B-XX | 0.75 | 11 | 4.2 | A |
| GD27-1R5G-S2-B-XX | 1.5 | 18 | 7.5 | B |
| GD27-2R2G-S2-B-XX | 2.2 | 24.3 | 10 | B |
| AC 3PH 200V~240V | | | | |
| GD27-0R4G-2-B-EU | 0.4 | 3.6 | 2.5 | A |
| GD27-0R7G-2-B-EU | 0.75 | 7 | 4.2 | A |
| GD27-1R5G-2-B-EU | 1.5 | 11.6 | 7.5 | B |
| GD27-2R2G-2-B-EU | 2.2 | 16 | 10 | B |
| GD27-004G-2-B-EU | 4 | 22.3 | 16 | C |
| AC 3PH 380V~480V | | | | |
| GD27-0R7G-4-B-XX | 0.75 | 4.5 | 2.5 | A |
| GD27-1R5G-4-B-XX | 1.5 | 6.5 | 3.7 | A |
| GD27-2R2G-4-B-XX | 2.2 | 8.8 | 5.5 | B |
| GD27-003G-4-B-XX | 3 | 12.2 | 7.5 | B |
| GD27-004G-4-B-XX | 4 | 15.6 | 9.5 | B |
| GD27-5R5G-4-B-XX | 5.5 | 22.3 | 14 | C |
| GD27-7R5G-4-B-XX | 7.5 | 28.7 | 18.5 | C |

Note: -XX indicates empty or -EU. -EU indicates the STO and EMC filter have been embedded.

Reactor & filter model selection

| VFD | Reactor | | Filter | |
|-------------------|-----------------|-----------------|---------------|---------------|
| | Input reactor | Output reactor | Input filter | Output filter |
| GD27-0R4G-S2-B-XX | / | / | FLT-PS2010H-B | FLT-L04006L-B |
| GD27-0R7G-S2-B-XX | / | / | | |
| GD27-1R5G-S2-B-XX | / | / | FLT-PS2025L-B | FLT-L04016L-B |
| GD27-2R2G-S2-B-XX | / | / | | |
| GD27-0R4G-2-B-EU | GDL-ACL0005-4CU | GDL-OCL0005-4CU | FLT-P04006L-B | FLT-L04006L-B |
| GD27-0R7G-2-B-EU | GDL-ACL0005-4CU | GDL-OCL0005-4CU | | |
| GD27-1R5G-2-B-EU | GDL-ACL0014-4CU | GDL-OCL0010-4CU | FLT-P04016L-B | FLT-L04016L-B |
| GD27-2R2G-2-B-EU | GDL-ACL0014-4CU | GDL-OCL0010-4CU | | |
| GD27-004G-2-B-EU | GDL-ACL0020-4CU | GDL-OCL0020-4CU | FLT-P04032L-B | FLT-L04032L-B |
| GD27-0R7G-4-B-XX | GDL-ACL0005-4CU | GDL-OCL0005-4CU | | |
| GD27-1R5G-4-B-XX | GDL-ACL0005-4CU | GDL-OCL0005-4CU | FLT-P04006L-B | FLT-L04006L-B |
| GD27-2R2G-4-B-XX | GDL-ACL0006-4CU | GDL-OCL0006-4CU | | |
| GD27-003G-4-B-XX | GDL-ACL0014-4CU | GDL-OCL0010-4CU | FLT-P04016L-B | FLT-L04016L-B |
| GD27-004G-4-B-XX | GDL-ACL0014-4CU | GDL-OCL0010-4CU | | |
| GD27-5R5G-4-B-XX | GDL-ACL0020-4CU | GDL-OCL0014-4CU | FLT-P04016L-B | FLT-L04016L-B |
| GD27-7R5G-4-B-XX | GDL-ACL0025-4CU | GDL-OCL0020-4CU | FLT-P04032L-B | FLT-L04032L-B |





Note: -XX indicates empty or -EU. -EU indicates the STO and EMC filter have been embedded.

Above options are external installation, customer need to specify them when choosing and purchasing.

And it can be flexibly adjusted according to the rated working current value.

For reactors selection with different material requirements from the above recommended table, please refer to «Low Voltage VFD GDL Series Filter Option Brochure» .

Accessory model selection

| Common keypad | Keypad with parameter | Keypad bracket 1 | Keypad bracket 2 | DIN rail mounting bracket |
|---|--|---|--|--|
|  |  |  |  |  |
| Order No. (with packaging): 11022-00121 Function: The LED keypad can be mounted externally. | Order No.(with packaging): 11022-00129 Function: The LED keypad can be mounted externally and can be used to upload and download parameters, facilitating commissioning. | Order No.(with packaging): 61001-00090 Function: It is used to fix the LED keypad when the LED keypad is mounted to the electrical cabinet. | Order No.(with packaging): 11022-00136 Function: It is used to fix the LED keypad when the LED keypad is mounted to the electrical cabinet. The keypad can be removed from the bracket directly. | Order No.(with packaging): 11091-00014 Function: It is used for DIN rail mounting, facilitating the mounting efficiency. |

Mounting method

Wall mounting

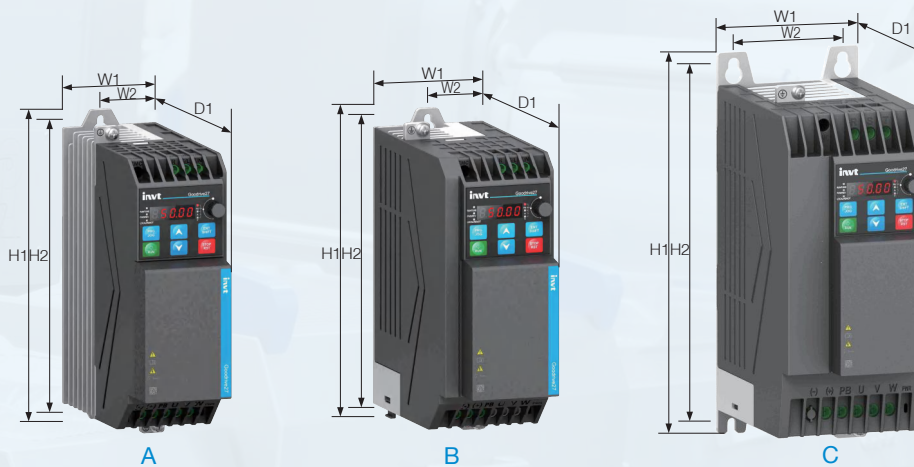

Wall mounting dimensions (unit: mm)

| VFD model | Outline dimensions (mm) | | | Mounting hole distance (mm) | | Mounting hole diameter (mm) | Frame |
|-------------------|-------------------------|-----|-----|-----------------------------|-----|-----------------------------|-------|
| | W1 | H1 | D1 | W2 | H2 | | |
| GD27-0R4G-S2-B-XX | 60 | 190 | 155 | 36 | 180 | Ø5 | A |
| GD27-0R7G-S2-B-XX | 60 | 190 | 155 | 36 | 180 | Ø5 | A |
| GD27-1R5G-S2-B-XX | 70 | 190 | 155 | 36 | 180 | Ø5 | B |
| GD27-2R2G-S2-B-XX | 70 | 190 | 155 | 36 | 180 | Ø5 | B |
| GD27-0R4G-2-B-EU | 60 | 190 | 155 | 36 | 180 | Ø5 | A |
| GD27-0R7G-2-B-EU | 60 | 190 | 155 | 36 | 180 | Ø5 | A |
| GD27-1R5G-2-B-EU | 70 | 190 | 155 | 36 | 180 | Ø5 | B |
| GD27-2R2G-2-B-EU | 70 | 190 | 155 | 36 | 180 | Ø5 | B |
| GD27-004G-2-B-EU | 90 | 235 | 155 | 70 | 220 | Ø5 | C |
| GD27-0R7G-4-B-XX | 60 | 190 | 155 | 36 | 180 | Ø5 | A |
| GD27-1R5G-4-B-XX | 60 | 190 | 155 | 36 | 180 | Ø5 | A |
| GD27-2R2G-4-B-XX | 70 | 190 | 155 | 36 | 180 | Ø5 | B |
| GD27-003G-4-B-XX | 70 | 190 | 155 | 36 | 180 | Ø5 | B |
| GD27-004G-4-B-XX | 70 | 190 | 155 | 36 | 180 | Ø5 | B |
| GD27-5R5G-4-B-XX | 90 | 235 | 155 | 70 | 220 | Ø5 | C |
| GD27-7R5G-4-B-XX | 90 | 235 | 155 | 70 | 220 | Ø5 | C |

Note: -XX indicates empty or -EU. -EU indicates the STO and EMC filter have been embedded.

INVT marketing service network

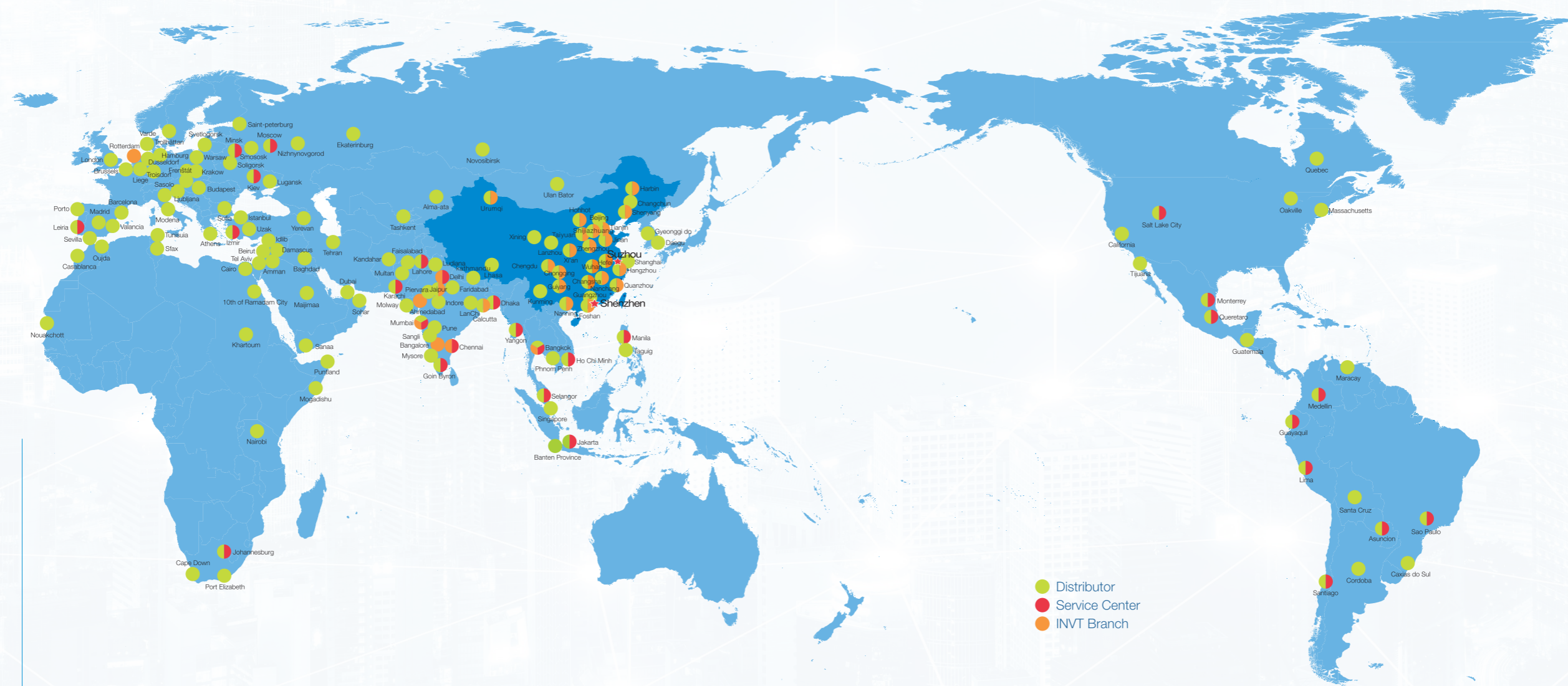

Factories* **3**

Headquarter in Shenzhen

Overseas Subsidiaries and offices* **8**

More than **100** Overseas Partners

Your trusted industry automation solution provider

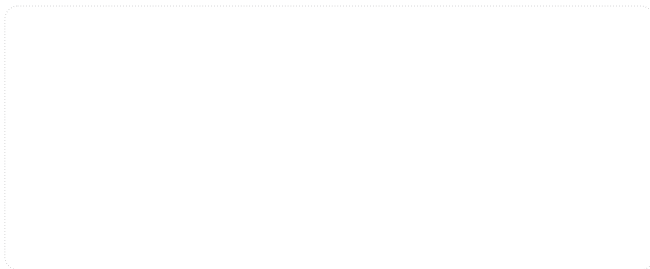

E-mail:overseas@invt.com.cn Website:www.invt.com

SHENZHEN INVT ELECTRIC CO.,LTD. INVT Guangming Technology Building, Songbai Road, Matian, Guangming District, Shenzhen, China

- Industrial Automation:
- HMI
 - PLC
 - VFD
 - Servo System
 - Elevator Intelligent Control System
 - Rail Transit Traction System
- Electric Power:
- UPS
 - DCIM
 - Solar Inverter
 - New Energy Vehicle Powertrain System
 - New Energy Vehicle Charging System
 - New Energy Vehicle Motor

INVT Copyright.
Information may be subject to change without notice during product improving.

66003-00303 202408(V1.1)